

# Manitowoc Cranes

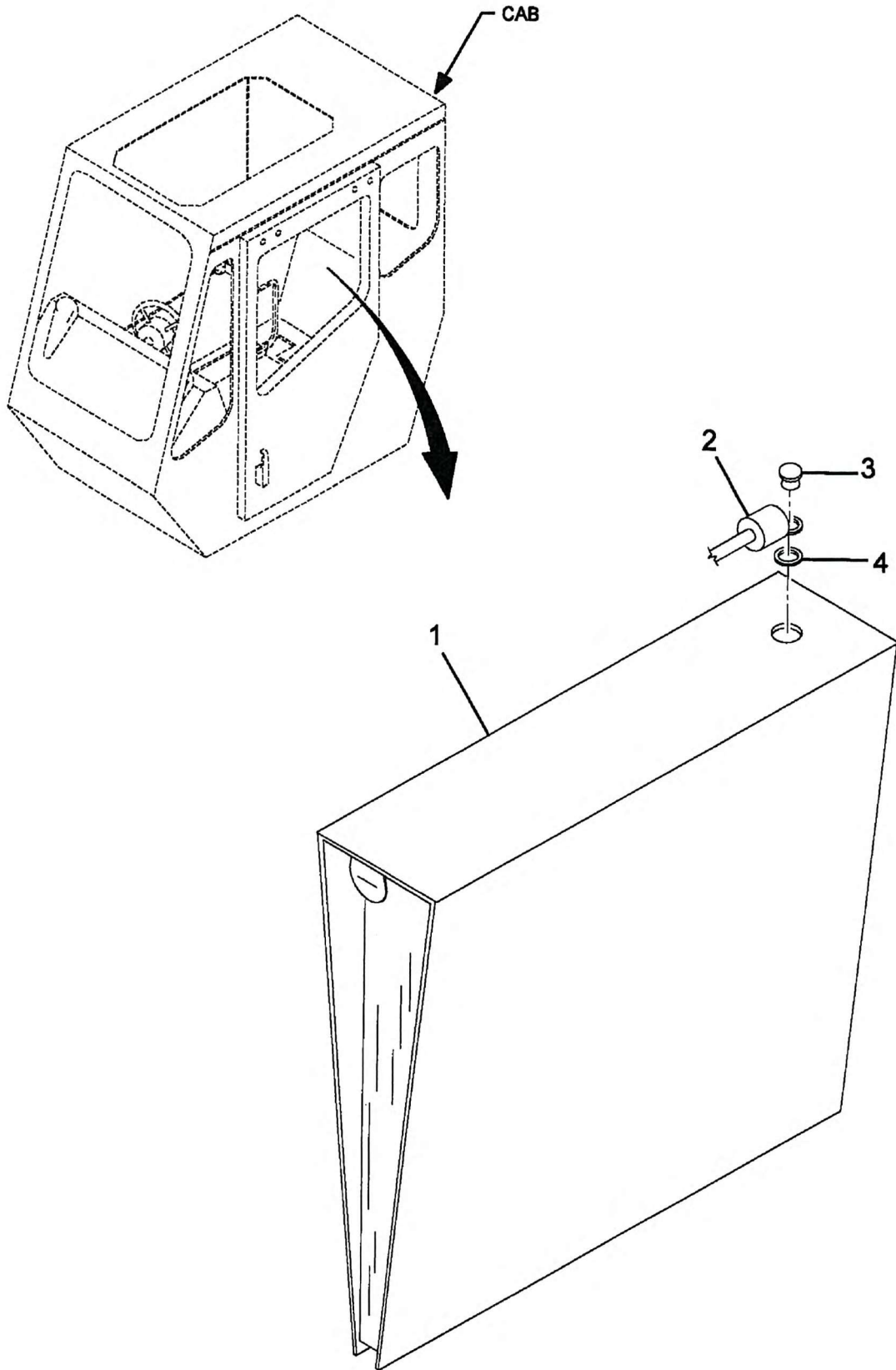

6258100005

(SHEET 1 OF 1)

Page 338